

AMB/100HR.20C Biaxial MEMS High Resolution DC Response Accelerometer

±100g range, 20mV/g sensitivity



The AMB range of accelerometers are Biaxial MEMS (micro electro mechanical system) DC response voltage output devices for testing at low frequency vibration measurement from DC (0Hz) and above. They are Biaxial (measuring in 2 directions simultaneously) variable capacitance design. The AMB/100HR.20C has a 4 pin ¼-28UNF side entry connector.

Ideally suited to low frequency vibration applications including low level vibration where high sensitivity is required.

Due to their ability to measure DC response they can also be used to measure constant gravity application.

The AMB/100HR.20C has a range of ±100g and a sensitivity of 20mV/g, we recommend using with DJB's MEMS signal conditioner the DCM-03

AMB/100HR.20C

Dimensions in mm

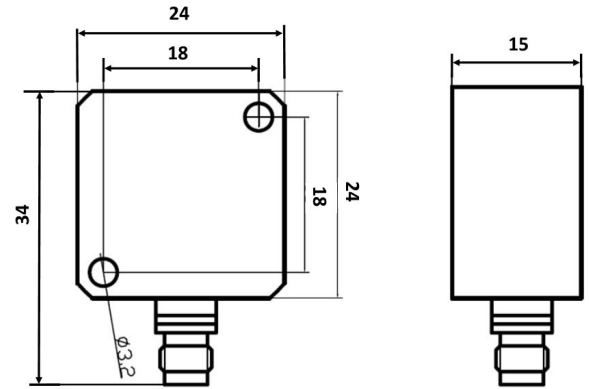

Features:

- Operational frequency range DC to 1600Hz
- ¼-28UNF 4 pin connector
- DJB signal conditioner model DCM-03 available as an option
- Differential Capacitance operation
- Compact form and low mass
- Constant gravity measurement

Applications:

- Auto/Aero structural body surveys
- Constant gravity measurements
- General vibration measurement
- Seismic vibration measurement
- Crash testing

Typical Temperature Response

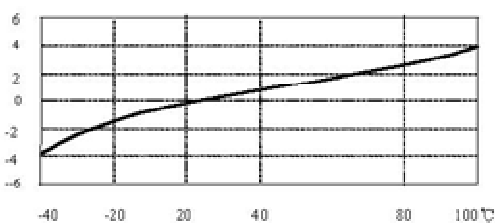

Typical Frequency Response

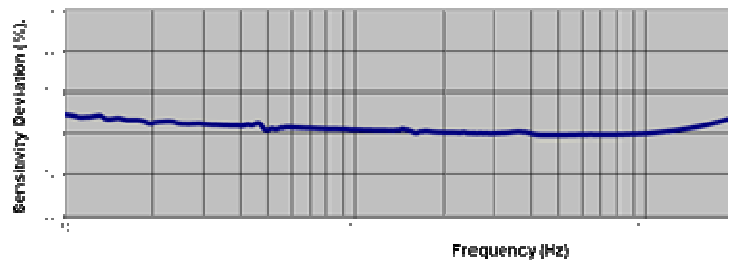

Please note: For information and reference only. Data should not be used as pass / fail criteria for calibration purposes.

DJB Instruments (UK) Ltd

Finchley Avenue,
Mildenhall, Suffolk IP28 7BG

Tel +44 (0)1638 712 288
Email sales@djbinstruments.com
Web www.djbinstruments.com

DJB Iss.4.2021

A UK company with UK-based manufacturing, assembly and calibration in-house.



ISO 9001 – 00025363

AMB/100HR.20C Biaxial MEMS High Resolution DC Response Accelerometer

±100g range, 20mV/g sensitivity



	Metric	Imperial
Sensitivity (20°C)	2mV/(m/s ²)±10%	20mV/g±10%
Measurement Range	±980m/s ² pk	±100g pk
Transverse sensitivity	≤5%	
Frequency Range (±5%)	DC to 1500 Hz	
Frequency Range (±10%)	DC to 1600Hz	
Mounted Resonance Frequency	5,000 Hz	
Temperature Range	-40 to +120°C	-40 to +248°F
Temperature Sensitivity	0.1 mV/°C	
Shock limit (No Supply)	29,420m/s ²	±3,000g
Power Supply	+6 to +30 VDC	
Operating Current	≤5mA	
Offset Voltage	2.5±0.1VDC	
Noise(100Hz)	< 0.14mVrms	
Resolution	28mq (rms)	
Weight	18grams	0.63oz
Case material	Titanium	
Case sealing	Hermetic	
Mounting	2 x Ø3.2mm hole	2 x Ø0.12inch holes
Connector Exit	Side	
Size	24 x 24 x 15mm	0.94x 0.94 x 0.59 inches
IP rating	IP65	

Options:

- DCM-03 – 3 channel MEMS signal conditioning unit.
- Pigtail cable terminations

Please note: For information and reference only. Data should not be used as pass / fail criteria for calibration purposes.

DJB Instruments (UK) Ltd

Finchley Avenue,
Mildenhall, Suffolk IP28 7BG

Tel +44 (0)1638 712 288
Email sales@djbinstruments.com
Web www.djbinstruments.com

A UK company with UK-based manufacturing, assembly and calibration in-house.

DJB Iss.4.2021



ISO 9001 – 00025363